

High Efficiency Self Contained Amplifier Module

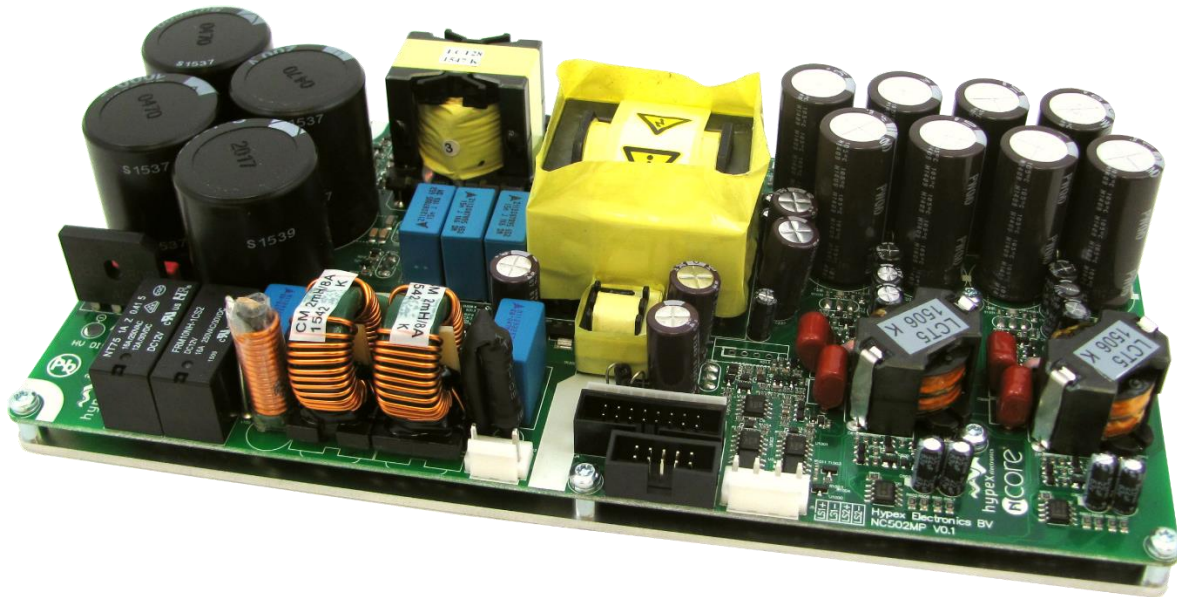

Image is for illustrative purposes only. Please refer to product description.

Highlights

- High efficiency
- Universal mains operation
- Flat, fully load-independent frequency response
- Low output impedance
- Very low, frequency-independent THD
- Very low noise

Features

- Two channel amplifier
- 5W standby SMPS
- Advanced over current protection
- External controlled operation
- Auto-switching (115/230V)
- Low weight: 1055 gr.
- Compact: 230 x 115 x 47mm

Applications

- Monitor loudspeakers for recording and mastering studios
- Audiophile power amplifiers for professional and consumer use.
- Public address systems
- Active loudspeakers

Introduction

The NC502MP amplifier module incorporates a low power standby power supply (meets 2013 ERP Lot 6 0.5W requirements), a highly efficient switch mode power supply and a high-performance Class D amplifier in one compact and easily applicable power brick.

The amplifier used in the NC502MP is a self-contained high-performance class D amplifier intended for a wide range of audio applications, ranging from public address systems to ultrahigh-fidelity replay systems for studio and home use. Chief distinguishing features are flat frequency response irrespective of load impedance, nearly frequency independent distortion behaviour and very low radiated and conducted EMI. Control is based on a phase shift controlled self-oscillating loop taking feedback only at the speaker output.

The main SMPS providing the power for the amplifier is a compact, high power, highly efficient, regulated half bridge converter with synchronous rectification on the main output rails. These properties make this technology ideal for powering Class D audio amplifiers.

For applications requiring a standby mode, a low power standby SMPS also has been integrated into this product. To achieve universal mains input compatibility this SMPS features an automatic input voltage doubler.

The Hypex Channel Extension connector provides for an additional low power tweeter amplifier channel.

Please make sure you always download the latest datasheet from our website.

Contents

Highlights	1
Features	1
Applications	1
Introduction	1
Contents	2
1 Safety precautions	3
1 Précautions de sécurité	3
2 The NC-MP Series	4
3 Electrical Specifications	5
3.1 Power Specifications	5
3.2 Standby SMPS	5
3.3 Main SMPS	5
3.4 Ncore Amplifier Specifications	6
3.5 Ncore Amplifier Audio IO Characteristics	7
3.6 Timing Specifications	7
4 Environmental Specifications	8
4.1 Heat dissipation	8
5 Product Markings	8
6 IO Specifications	9
6.1 Power Supply Enable	9
6.2 Amplifier Mute	9
6.3 DC-Error	9
6.4 Power Good	9
6.5 Amplifier Clip Indicator	9
6.6 Temperature Readout	10
6.7 Current sense output	10
7 Connector Pinouts	11
7.1 H-Box connector	11
7.2 H-Bus connector	12
7.3 H-Channel extension	12
7.4 Loudspeaker Connector	12
7.5 AC Connector Specification	12
8 Typical Performance Graphs	13
9 Dimensions	14
9.1 Drill pattern (next page)	14
10 Bridge-tied load (BTL)	16
10.1 Typical Performance Graphs BTL	16
11 Revisions	17
12 Disclaimer	17

1 Safety precautions

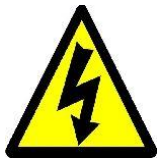

This module operates at mains voltage and carries hazardous voltages at accessible parts. These parts may never be exposed to inadvertent touch. Observe extreme care during installation and never touch any part of the unit while it is connected to the mains.

Disconnect the unit from the mains and allow all capacitors to discharge for 10 minutes before handling it.



Attention: Observe precautions for handling electrostatic sensitive devices. This module uses semiconductors that can be damaged by electrostatic discharge (ESD).

Damage due to inappropriate handling is not covered by warranty.

This product has no user-serviceable parts.



This symbol indicates the presence of hazardous voltages at accessible conductive terminals on the board. Parts that are not highlighted in red may also carry voltages in excess of 160 Vdc!

Warning: To reduce the risk of fire or electric shock, do not expose this apparatus to rain or moisture.

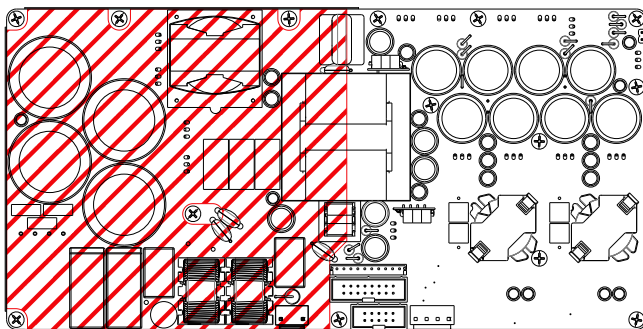

This is a Safety Class 2 device. When mounting the module in an enclosure, a minimum safety distance of 6mm from the module to all possible conducting parts must be ensured to keep compliance with Safety Class 2. All parts highlighted in red carry hazardous voltages. This includes parts on the top and the bottom of the board.

When this module is mounted in a tight space there needs to be at least 6mm clearance or a layer of insulation with a minimum thickness of 0.5mm between the top of the transformer and the housing.

1 Précautions de sécurité



Ce module est sous tension secteur et certaines de ses pièces accessibles sont sous une tension dangereuse. Ces pièces doivent dans tous les cas être protégées contre contacts accidentels. Lors de l'installation, une prudence extrême s'impose. Ne jamais toucher les pièces du module quand celui-ci est relié au secteur. Isoler l'appareil du secteur et attendre 10 minutes pour laisser à tous les condensateurs le temps de se décharger avant de le manipuler.



Attention : Respecter les consignes de sécurité pour la manipulation d'appareils sensibles aux courants électrostatiques. Ce module est pourvu de semi-conducteurs qui peuvent être endommagés par les décharges électrostatiques (DES).

Les dommages causés par un usage non approprié sont exclus de la garantie.

Ce produit ne contient aucune pièce devant être entretenue par l'utilisateur.



Ce symbole indique la présence de tensions dangereuses aux broches de raccordement accessibles sur la carte. Les pièces non marquées en rouge peuvent être elles aussi sous une tension supérieure à 160 VCC.

Avertissement: Pour réduire les risques de choc électrique, ne pas exposer cet appareil à la pluie ou l'humidité.

1. Read these instructions.
2. Keep these instructions.
3. Heed all warnings.
4. Follow all instructions.
5. Do not use this apparatus near water.
6. Protect the power cord from being walked on or pinched, particularly at plugs, convenience receptacles, and the point where they exit from the application.
7. Only use attachments/accessories specified or approved by the manufacturer.
8. Unplug this apparatus during lightning storms or when unused for long periods of time.
9. Refer all servicing to qualified service personnel. Servicing is required when the apparatus has been damaged in any way, liquid has been spilled or objects have fallen into the apparatus, the apparatus has been exposed to rain or moisture, does not operate normally or has been dropped.
10. Don't run any cables across the top or the bottom of the module. Apply fixtures to cables to ensure that this is not compromised.
11. Observe a minimum clearance of 6mm with all possible conducting parts (housing etc.).
12. Natural convection should not be impeded by covering the module (apart from the end applications housing).
13. Before using this product, ensure all cables are correctly connected and the power cables are not damaged. If you detect any damage, do not use the product.
14. Changes or modifications not expressly approved by Hypex Electronics will void compliance and therefore the user's authority to operate the equipment.
15. Service or modifications by any person or persons other than by Hypex Electronics authorized personnel voids the warranty.

2 The NC-MP Series

The NC-MP series is a range of mains powered Ncore amplifiers both single and dual channel. Next to the mains powered modules, this range of modules also include a single channel add-on module. This module can be used to add one extra channel to a mains powered module. In the next table, there is an overview of the different models and their output power.

Model	Single channel, 4 Ohm	Dual channel, 4 Ohm
NC122MP	-	2 x 125 W
NC250MP	1 x 250 W	-
NC252MP	-	2 x 250 W
NC500MP	1 x 500 W	-
NC502MP	-	2 x 500 W
NC100HF	Hypex Channel Extension for tweeter	

The NC-MP is an all-in-one module, designed to be applied in a single module configuration and is certified as such. If a multi NC-MP setup is desired, one should take care of EMI, EMC, inrush currents and other related phenomena.

Evaluation kit

For quick and easy evaluation, Hypex offers a special connection kit. This kit is specifically designed to make it easy to evaluate the new NCxxxMP series mains powered Ncore modules. Furthermore, the NC100HF can be easily connected using a 8-pin box interface cable. A 10-pin JST interface cable is included to connect the NC100HF with the NCxxxMP. The breakout board features three Molex Micro-Fit 3.0 connectors for audio input signals (Molex cable-end part no: 43025-0400). The evaluation board comes with 10mm nylon spacers which can be used to mount the board using M3 screws. For more information, go to our website.

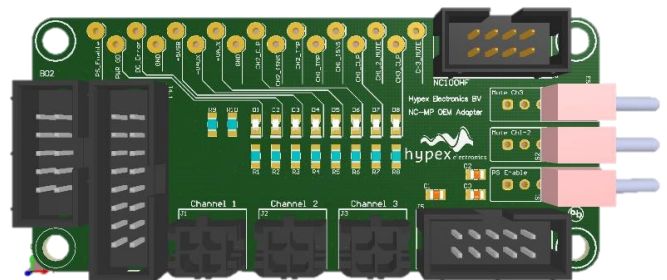

Cables

In addition to this evaluation kit, Hypex offers cable sets to interface between the modules and the application. These cables have a standardized length. For more information, visit our website.

3 Electrical Specifications

3.1 Power Specifications

Parameter	Remarks	Symbol	Min	Typ	Max	Unit	Note
High Line Input Voltage	-	V _B	200-240Vac ±10%			Vac	1)
Low Line Input Voltage	-	V _{B,FP}	100-120Vac ±10%			Vac	1)
Line Input Frequency	-	f	47		63	Hz	1)
Fuse rating	250Vac, slow blow			12		A	2)

Note 1: The unit will automatically switch to the correct line input configuration at start up. Operation beyond these limits may result in irreversible damage.

Note 2: Fuse is soldered on the PCB and is therefore not user replaceable.

3.2 Standby SMPS

The standby power supply is immediately active upon connection to the mains and can therefore be used to power external control circuitry and to operate the PS Enable pin.

Parameter	Remarks	Symbol	Min	Typ	Max	Unit	Note
Output voltage	-	V _{OUT}	4.9	5	5.1	Vdc	
Output current	Continuous	I _{OUTMAX}	-	-	1	A	1)
Output current	For ERP compliance	I _{OUTERP}	-	-	26	mA	
External capacitance	-		-	-	4700	µF	
Switching frequency		F _{SW.Stb}	-	65	100	kHz	
Efficiency	Full power	η	74	-	-	%	
Standby power	No load	P _{Stb}	-	-	0.25	W	
Output voltage Ripple		V _{RIPPLE}	-	-	0.1	V	

Note 1: Protected against shorting and overloading. Power supply will shut down and needs resetting of the mains input.

3.3 Main SMPS

Parameter	Remarks	Symbol	Min	Typ	Max	Unit	Note
Efficiency	Full power	η		92		%	
Idle Losses	230 Vac, 50 Hz	P ₀		17		W	
In-rush current	10Ω In-rush NTC, worst-case	I _{Inrush}		55		A	
Switching frequency		F _{SW}	90	110	240	kHz	
Power consumption	Full power amplifier, 0.5A V _{AUX} , 1A Standby	P _{max}		1.2		kW	
Output Voltage V _{AUX}	Positive	V _{AUX}	±17	±18	±19	Vdc	
Output Current V _{AUX}	Positive rail	I _{AUX +}	-	-	1	Adc	
	Negative rail	I _{AUX -}	-	-	0.5	Adc	
External capacitance	-		-	-	2200	µF	

3.4 Ncore Amplifier Specifications

Parameter	Remarks	Symbol	Min	Typ	Max	Unit	Note
Max Output Power	1KHz, THD=1%, All channels driven. Per channel.	$P_{R, 2\Omega}$	-	-	450	W_{rms}	1)4)
		$P_{R, 4\Omega}$	-	-	500	W_{rms}	1)
		$P_{R, 8\Omega}$	-	-	350	W_{rms}	1)5)
Continuous Output Power	Per channel, 25°C ambient temperature.	$P_{R, cont}$	-	100	-	W_{rms}	2)
Distortion	<10Hz-20kHz AES17 $P_{out} < P_R / 2$	THD+N	-	0.00 18	0.00 24	%	3)
	<10Hz-20kHz AES17 $P_{out} = 1W$		-	-	0.00 24	%	3)
CMRR			-	63	-	dB	
Signal-to-Noise Ratio			-	124	-	dB	
Output Noise	Unwtd, <10Hz-20kHz AES17, 0Ω termination	U_N	-	-	40μ	V	
Output Impedance	f<1kHz	Z_{OUT}	-	-	2.6	mΩ	
	f<20kHz		-	-	3	mΩ	
Power Bandwidth		PBW		20-35k		Hz	
Frequency Response	+0/-3dB. All loads.		10	-	50k	Hz	
Voltage Gain		A_v	25	25.5	26	dB	
Efficiency	Full power	η		92	-	%	
Idle Losses	Per channel	P_0	-	6.5	-	W	
Current Limit per Ch.	Hiccup both channels after limiting 40ms		-	27	-	A	

Note 1: The stimulus signal is a continuous 1 kHz sine wave. The true rms output voltage is measured across a load resistor. Max output power is time limited due to thermal properties.

Note 2: Typically, this is 1/5 of the peak output power. Apply sufficient cooling.

Note 3: An Audio Precision AES17 20 kHz is used during this measurement.

Note 4: Current limited.

Note 5: Voltage limited

3.5 Ncore Amplifier Audio IO Characteristics

Parameter	Remarks	Symbol	Min	Typ	Max	Unit	Note
Input Impedance	Either input to ground	Z _{IN}		47k		Ω	
Loudspeaker impedance range		Z _{L,SE}	2	4	-	Ω	

Signal Coupling

To achieve optimal signal coupling, the audio signal inputs are all DC coupled. One must make sure that the connected application is free of DC offset.

Balanced or unbalanced

All Hypex modules are completely balanced for optimal performance. The modules can be connected to an unbalanced source. To do this correctly, please read our application notes: 'Dealing with legacy pin 1 problems' and 'Amplifier signal input wiring'.

Input buffer and gain

This module is equipped with an input buffer. It is not possible to change or bypass the input buffer. Furthermore, changing the gain of the module is not supported.

Input sensitivity

Below a formula is given to calculate the balanced input signal level for a desired output level. An example is given using P_{RATED} 500W, Load 4Ω, Gain 25.6

$\frac{\sqrt{P_{RATED} * \Omega_{LOAD}}}{10^{\left(\frac{Gain}{20}\right)}} = Input V_{RMS}$	$V_{RMS} * \sqrt{2} = Input V_{Peak}$	$20 * \log_{10} \left(\frac{V_{RMS}}{0.7746} \right) = Input dBu$
↓	↓	↓
$\frac{\sqrt{500 * 4}}{10^{\left(\frac{25.6}{20}\right)}} = 2.35 V_{RMS}$	$2.35 * \sqrt{2} = 3.32 V_{Peak}$	$20 * \log_{10} \left(\frac{2.35}{0.7746} \right) = 9.63 dBu$

3.6 Timing Specifications

These timings are measured at room temperatures, approximately 21°C, 230Vac.

Parameter	Remarks		Min	Typ	Max	Unit	Note
Standby start up delay	Time mains presence, till standby supply is within operational limits			60		ms	
Switching start up delay	Time mains presence, till all power supplies are within operational limits	230V		210	400	ms	
		115V		770	1200	ms	
Output delay	Time delay to signal, from moment all power supplies are within operational limits			800		ms	
Mute delay	Time delay to mute			70		us	
Unmute delay	Time to unmute			100		us	
Shutdown delay	Supply failure or Standby pin			100		ms	

4 Environmental Specifications

Parameter	Remarks	Symbol	Min	Typ	Max	Unit	Note
Ambient Temperature	Storage		-25	-	70	°C	
	Operation	T _{amb}	0	-	50	°C	
Heat-sink Temperature		T _{h,max}			95	°C	
Humidity	Max 85 percent relative humidity, non-condensing.						

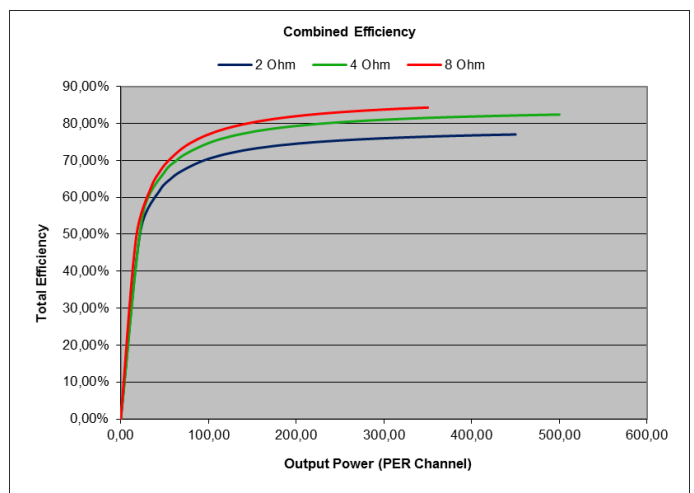
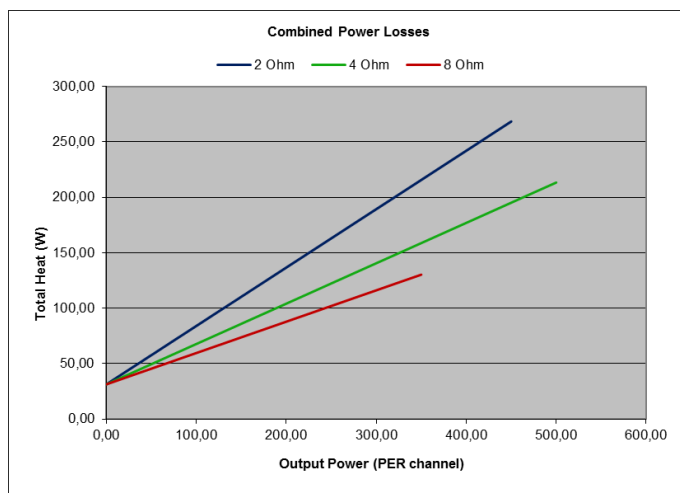

4.1 Heat dissipation

Class D amplifiers' known high efficiency often leads to a gross underestimation of the cooling required. Please apply adequate cooling to the module to ensure the module operates within specification. The following graphs provide an indication of the heat (in Watts) generated at different output levels. For more information regarding cooling, please refer to our application note "Thermal Design", available on our website. Defects caused by overheating due to poor thermal management are not covered by warranty.



5 Product Markings

Identification and supply ratings EN-IEC 60065. This module has two marking stickers applied.

Model sticker	Identification sticker example
<p>Hypex Electronics BV</p> <p>NC502MP</p> <p>AC115V~/AC230V~</p> <p>1200W MAX / 47-63Hz</p>  	 <p>wwyy</p> <p>7929-0202A12345-0123</p> <p>NC502MP</p>

6 IO Specifications

6.1 Power Supply Enable

By asserting the PS Enable pin of the H-Bus connector the Main-SMPS is enabled. The Standby-SMPS is enabled from the moment that the module is connected to mains. Therefore the Standby-SMPS can be used to activate the Main-SMPS. When the Main-SMPS is powered up, the amplifiers will be enabled, providing there is no failure and Amplifier Mute is not asserted.

Parameter	Remarks	Symbol	Min	Typ	Max	Unit	Note
SMPS enabled	Logic High level		3,3	-	12	Vdc	¹⁾
SMPS in standby	Logic Low level		-	-	0.8	Vdc	

Note 1: The current (A) drawn can be calculated as follows: $(V_{pin} - 0.7) / 22000$

6.2 Amplifier Mute

By asserting either of the Amplifier Mute pins on the H-Box connector both amplifiers will be muted. This pin may be left unconnected if the mute function is not used.

Parameter	Remarks	Symbol	Min	Typ	Max	Unit	Note
Amplifier mute	Logic High level		3,3	-	12	Vdc	¹⁾
Amplifier un-mute	Logic Low level		-	-	0.8	Vdc	

Note 1: The current (A) drawn can be calculated as follows: $(V_{pin} - 0.7) / 10000$

6.3 DC-Error

If a DC component is present at either of the speaker outputs, the nFatal bus will be pulled down. This triggers the main SMPS to switch off and the DC Error to be activated. To reset the DC Error the module must be disconnected from mains for at least 10 minutes to allow the primary capacitors to drain. A DC Error does not affect the standby SMPS.

Parameter	Remarks	Symbol	Min	Typ	Max	Unit	Note
Collector voltage	Open collector output		-	-	50	V	
Collector current	Open collector output		-	-	100	mA	

6.4 Power Good

The Power Good will be activated if the main SMPS is functioning correctly. If the main SMPS is disabled, the Power Good pin is immediately released.

Parameter	Remarks	Symbol	Min	Typ	Max	Unit	Note
Collector voltage	Open collector output		-	-	50	V	
Collector current	Open collector output		-	-	100	mA	

6.5 Amplifier Clip Indicator

If a clip condition occurs the Amplifier Clip Indicator pin will be pulled to ground.

Parameter	Remarks	Symbol	Min	Typ	Max	Unit	Note
Collector voltage	Open collector output		-	-	50	V	
Collector current	Open collector output		-	-	100	mA	

6.6 Temperature Readout

One NTC is placed near the amplifier FET's and can be used to monitor the temperature. The NTC is connected to GND and accessible via the H-Box connector. The characteristics of the NTC are stated in the datasheet of the NTC manufacturer.

Parameter	Remarks	Symbol	Min	Typ	Max	Unit	Note
Resistor value	100 °C – 25 °C		0.9	-	10	kΩ	
Permissible Operating Current	25°C				0.31	mA	

NTC type: NCP18XH103J03RB

6.7 Current sense output

The NC502MP features a linear current sense output for each amplifier channel. Its output sensitivity is 55mV/A and it has a DC-offset of 1.65 Vdc. The bandwidth of the output is 30 kHz.

In the graph on the right a theoretical representation is given of the possible output signal. In this example a 18A peak output signal is depicted.

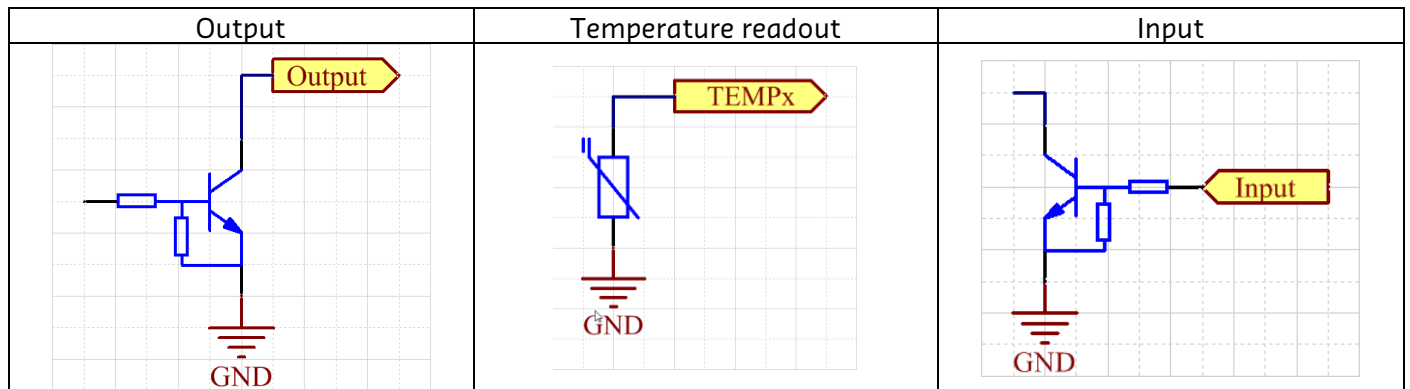
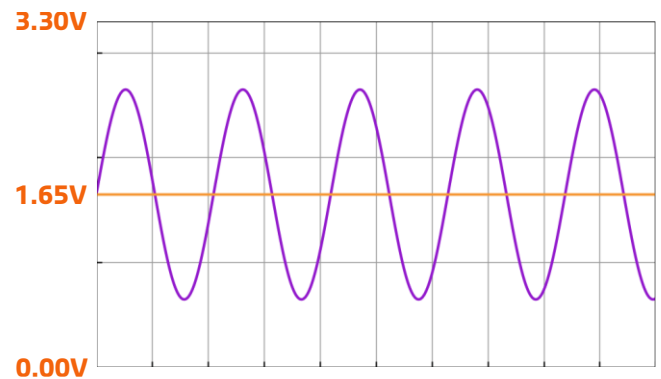

7 Connector Pinouts

This chapter describes the functional connectors of the amplifier module. A connector not stated in this chapter is only used for production or quality control and must remain unconnected in the end user appliance. The arrow points towards pin1 of the connector, for more information regarding a specific connector, please refer to the corresponding datasheet.

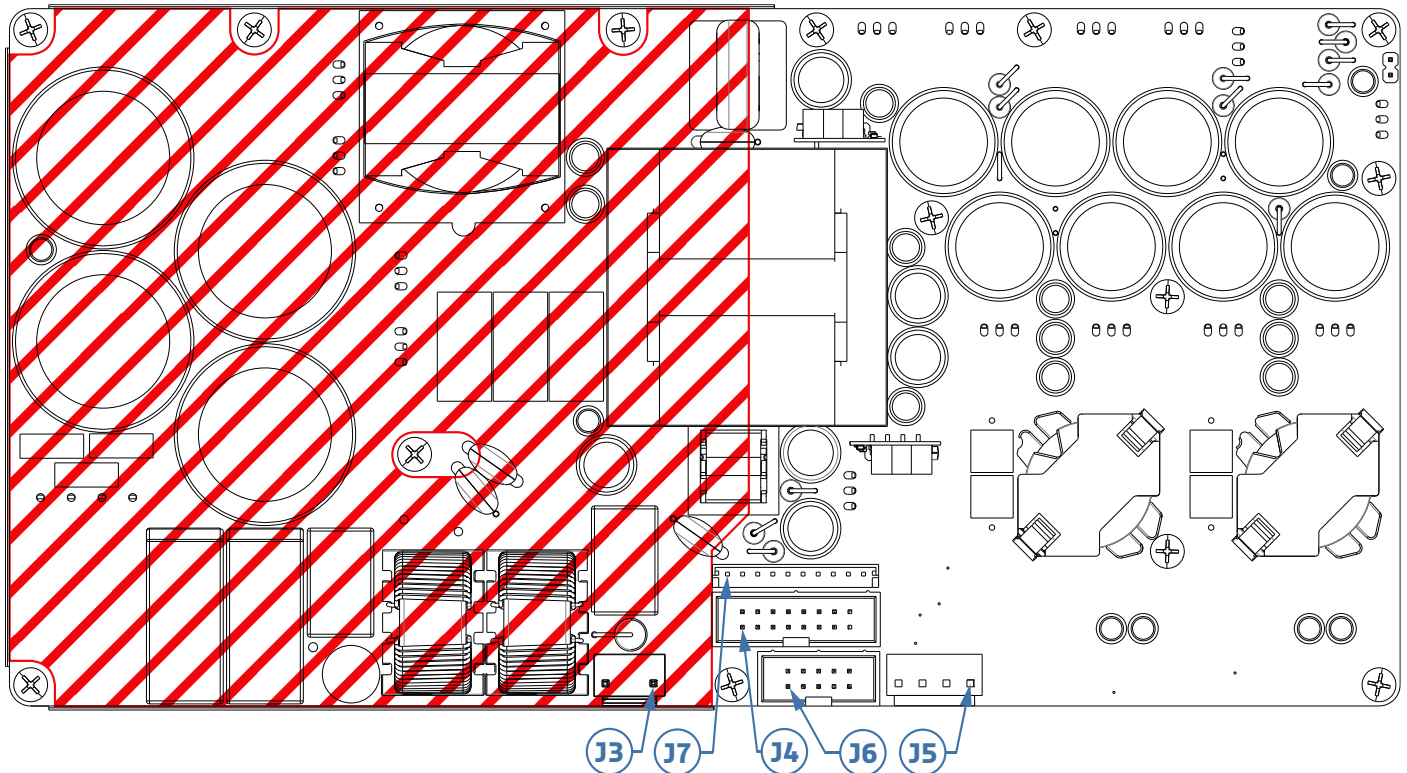

7.1 H-Box connector

Pin	Direction	Function	Remarks
J4.1	Input	CH1 In -	Inverting audio input Channel 1
J4.2	Input	CH1 In +	Non-inverting audio input Channel 1
J4.3	-	CH1 GND	Ground
J4.4	Input	Mute	Amplifier mute (both channels)
J4.5	Output	CH1 Clip	Clip indicator Channel 1
J4.6	Input	CH1 HWAddr	Not connected
J4.7	Output	CH1 ISense(1)	Current sense Channel 1
J4.8	Output	CH1 Thermal	Temperature readout Channel 1
J4.9	Output	CH2 Thermal	Temperature readout Channel 2
J4.10	Output	CH2 ISense(2)	Current sense Channel 2
J4.11	Input	CH2 HWAddr	Not connected
J4.12	Output	CH2 Clip	Clip indicator Channel 2
J4.13	Input	Mute	Amplifier mute (both channels)
J4.14	-	CH2 GND	Ground
J4.15	Input	CH2 In +	Non-inverting audio input Channel 2
J4.16	Input	CH2 In -	Inverting audio input Channel 2

Connector type equivalent: T821116A1S100CEU

Contact material: Brass, gold flash over nickel

7.2 H-Bus connector

Pin	Direction	Function	Remarks
J6.1	Output	V _{AUX}	Positive auxiliary supply
J6.2	Output	V _{AUX}	Negative auxiliary supply
J6.3	Output	V _{OUT,STANDBY}	Regulated standby supply
J6.4	-	GND	Ground
J6.5	n.c.	SDA (I ² C)	Not connected
J6.6	n.c.	SCL (I ² C)	Not connected
J6.7	Output	DC Error	DC Offset detected, power supply disabled.
J6.8	Output	Power Good	Power supply stable indicator
J6.9	Input	PS Enable	Power supply enable
J6.10	Reserved	Reserved	Not connected

Connector type equivalent: T821116A1S100CEU

Contact material: Brass, gold flash over nickel

7.3 H-Channel extension

The Hypex Channel Extension interface is designed for use with a single NC100HF tweeter amplifier and may therefore not be used for other purposes.

Pin	Direction	Function	Remarks
J7.1	Output	HV +	Positive power supply
J7.2	Output	HV -	Negative power supply
J7.3	-	GND	Ground
J7.4	Output	VDR	VDR power supply
J7.5	Input	nFatal	High if amplifier has no error
J7.6	Output	Positive V _{REG}	
J7.7	Output	Negative V _{REG}	
J7.8	Output	Amp Enable	Amplifier enable
J7.9	Reserved	Reserved	Not connected
J7.10	Reserved	Reserved	Not connected

Connector type: B10B-EH-A(LF)(SN)

7.4 Loudspeaker Connector

Pin	Direction	Function	Remarks
J5.1	-	LS2-	Cold Loudspeaker Output On-board Amp Channel 2
J5.2	Output	LS2+	Hot Loudspeaker Output On-board Amp Channel 2
J5.3	-	LS1-	Cold Loudspeaker Output On-board Amp Channel 1
J5.4	Output	LS1+	Hot Loudspeaker Output On-board Amp Channel 1

Connector type: B4P-VH(LF)(SN)

7.5 AC Connector Specification

Pin	Direction	Function	Remarks
J3.1	Input	Mains input	Neutral AC
J3.2	Input	Mains input	Phase AC

Connector type: B2P3-VH(LF)(SN)

8 Typical Performance Graphs

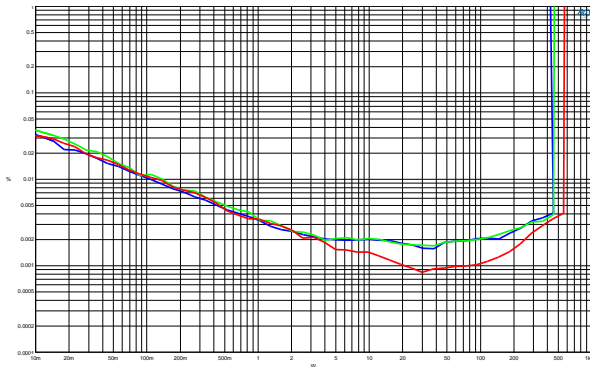

THD+N vs. power at 100Hz (blue), 1kHz (green) and 6kHz (red) (2Ω).

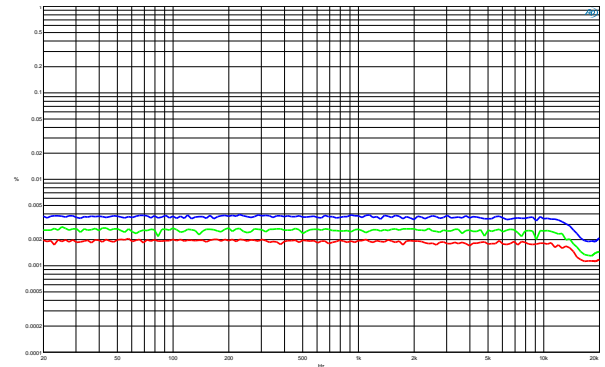

THD+N vs. Frequency at 1W in 2Ω (blue), 4Ω (green) and 8Ω (red).

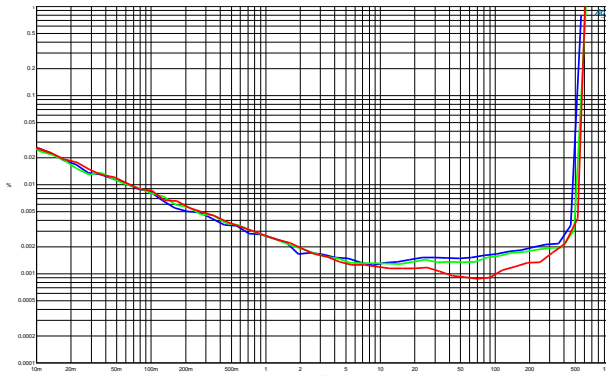

THD+N vs. power at 100Hz (blue), 1kHz (green) and 6kHz (red) (4Ω).

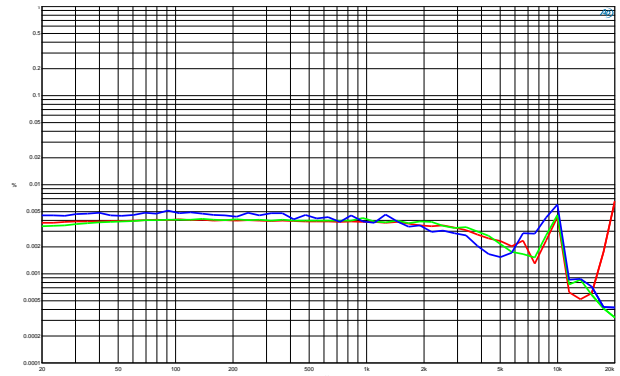

THD+N vs. Frequency at PR/2 in 2Ω (blue), 4Ω (green) and 8Ω (red).

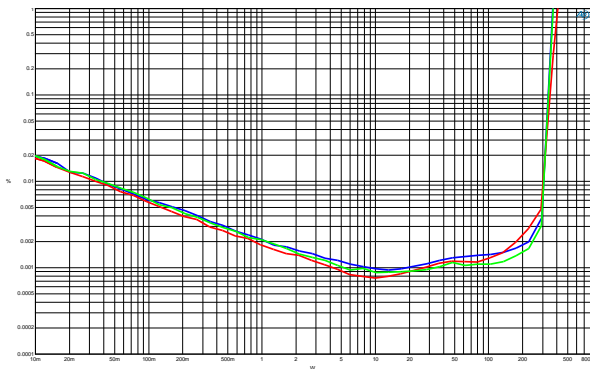

THD+N vs. power at 100Hz (blue), 1kHz (green) and 6kHz (red) (8Ω).

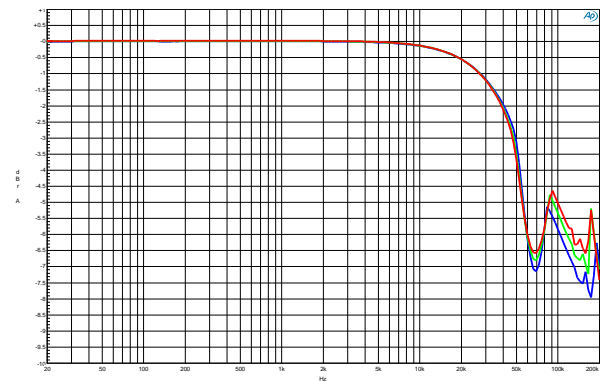

Frequency response in 2Ω (blue), 4Ω (green) and 8Ω (red).

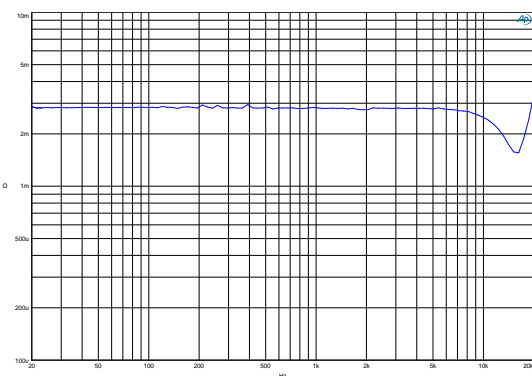

Output impedance

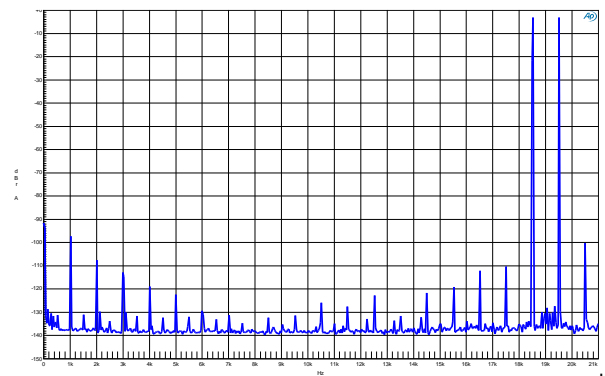

spectrum at 18.5kHz + 19.5kHz, PR/2 in 4Ω (blue).

9 Dimensions

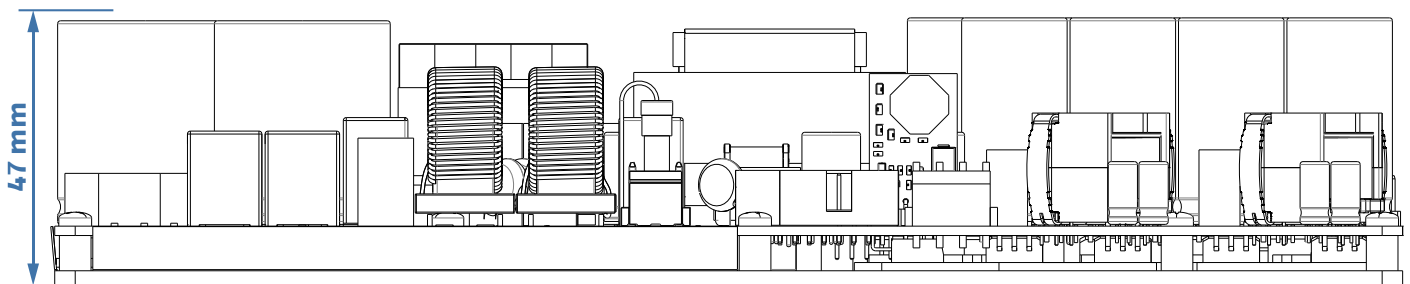
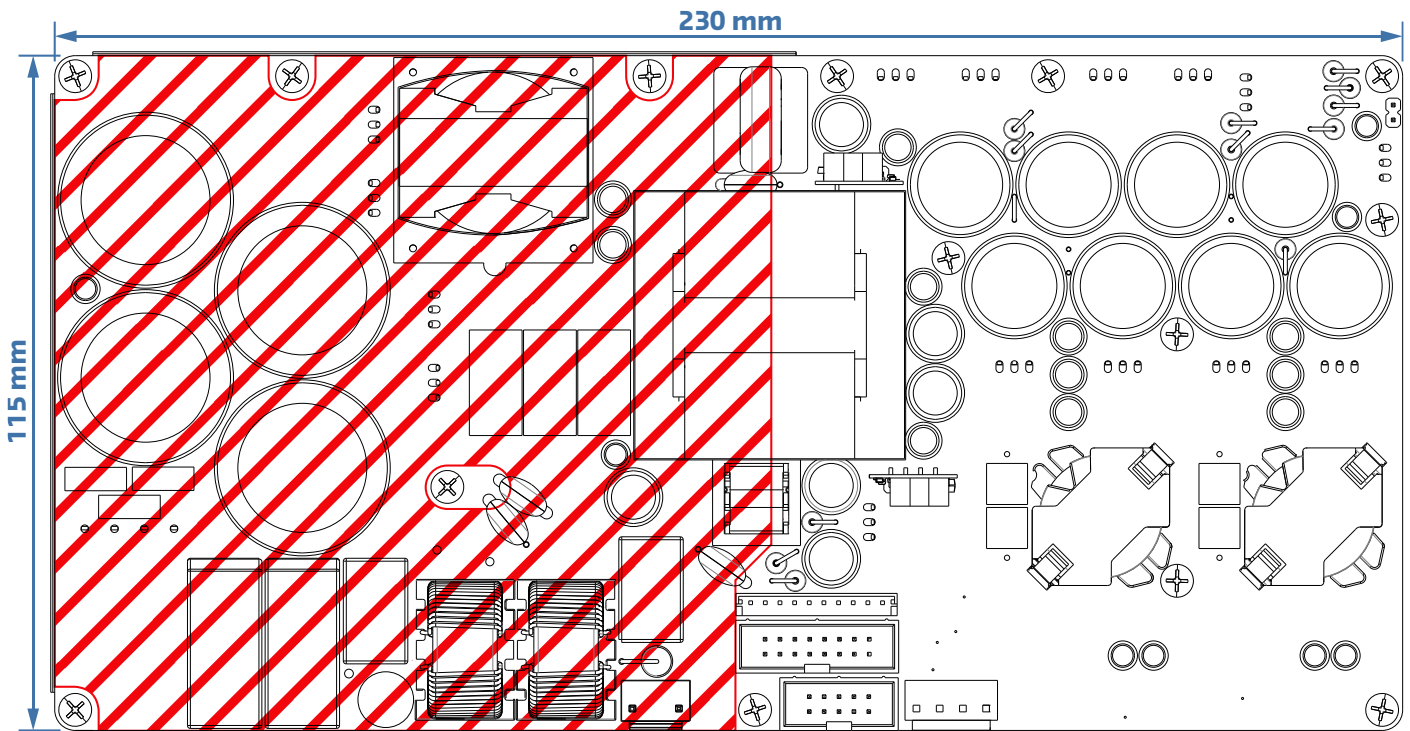

9.1 Drill pattern (next page)

If printed correctly (scale 100%, A4), the scale of the image below should be 1:1. You may use it as a model to drill holes in your casing. Please verify before drilling!

Maximum allowed protruding depth inside each spacer is 4mm. Spacer threads are M3.

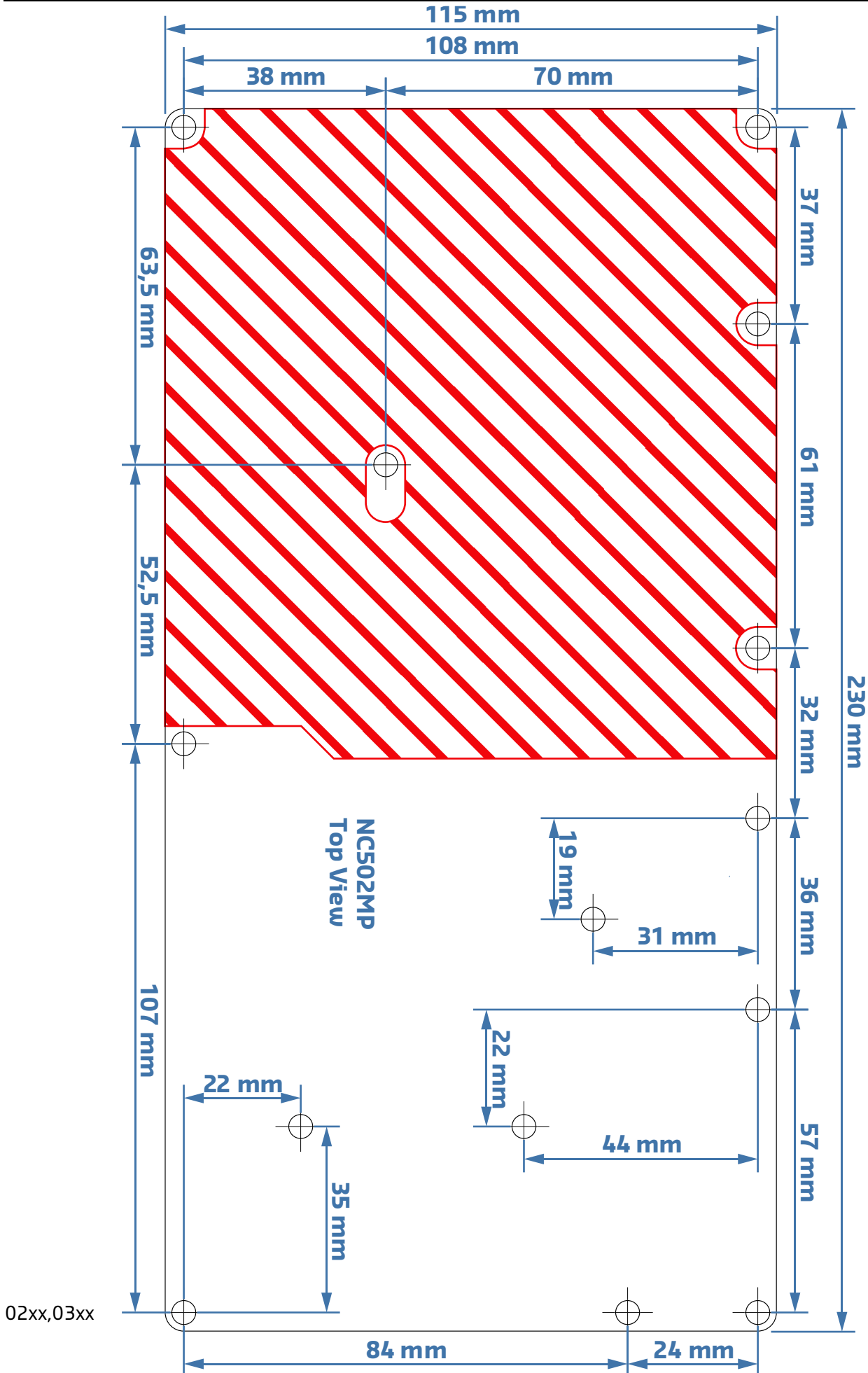

10 Bridge-tied load (BTL)

This two channel amplifier can be utilized in Bridge Tied Load configuration. This is especially useful for high impedance loads. In a bridge-tied load configuration, channel 1 is driving one side of a load and channel 2 is driving the other side of the load. The signal input of channel 2 is the inverted signal input of channel 1. Note that this does not affect the phase of the signal. A BTL configuration results in double the voltage swing across the load compared to a single-ended configuration where one side of the load is tied to an amplifier and the other side to ground.

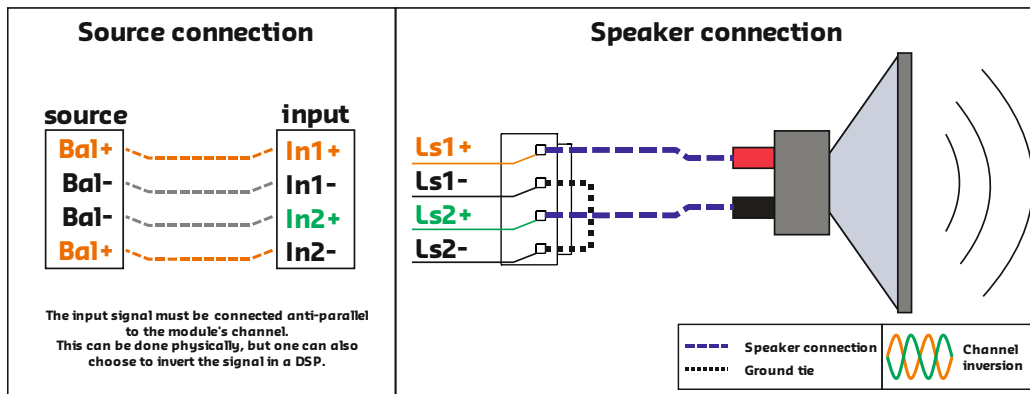

In the graphical representation above, the BTL principle is depicted. By inverting the signal input of the second channel, the output voltage amplitude is doubled. Please note that the negative (GND) output terminals are tied together. On the NC-MP modules, this is already implemented in the design and therefore these pins can be left unconnected.

In a bridge-tied load configuration, the load impedance which each amplifier channel 'sees' is half the characteristic impedance of the connected speaker. Therefore the minimum load in BTL configuration is 4Ω, however, we recommend to use only a BTL configuration with a load of 8Ω or higher.

Parameter	Remarks	Symbol	Min	Typ	Max	Unit	Note
Peak Output Power	1 KHz, THD=1%, Bridge-tied load (BTL)	$P_R, 4\Omega$	-	-	1	kW	
		$P_R, 8\Omega$	-	-	1.2	kW	
Voltage Gain	Bridge-tied load (BTL)	A_v	31	31.5	32	dB	
Loudspeaker impedance range	Bridge-tied load (BTL)	$Z_{L,SE}$	4	8	-	Ω	

10.1 Typical Performance Graphs BTL

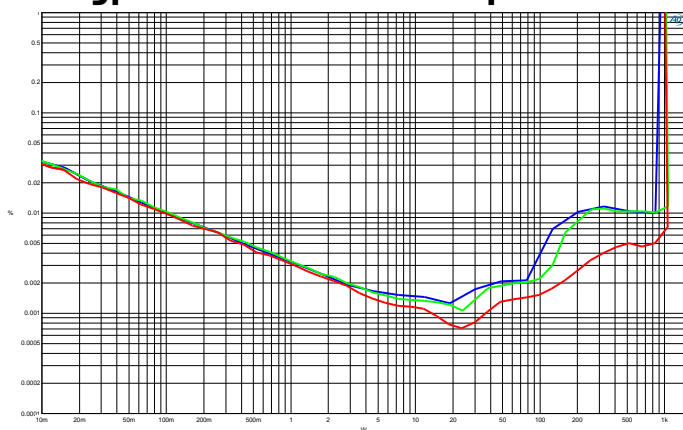

THD+N vs. power at 100Hz (blue), 1kHz (green) and 6kHz (red) (BTL - 4Ω).

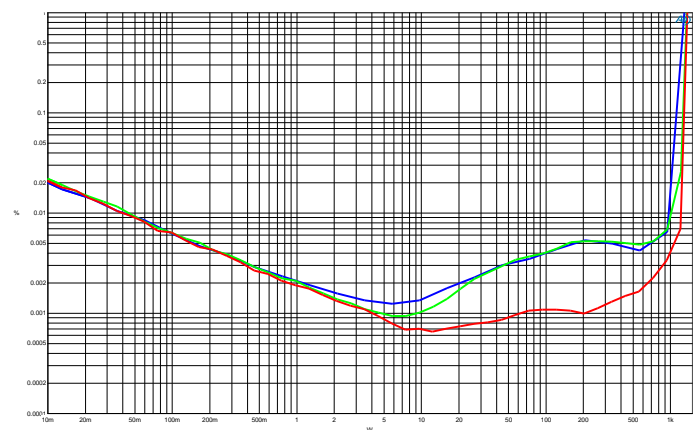

THD+N vs. power at 100Hz (blue), 1kHz (green) and 6kHz (red) (BTL - 8Ω).

11 Revisions

Document revision	Module revision	Change log	Date
01	NC502MP 01xx	Pre-release version	Oct '16
02	NC502MP 02xx NC502MP 03xx	Input buffer changed	Oct '16
03	"	Negative auxiliary output current corrected Graph THD+N vs. Frequency at PR/2 added	Oct '16
04	"	Irregularity in the Hypex-box corrected: differential signal inputs were swapped, resulting in a 180° phase shift.	Dec '16
05	"	Information added for safety standards approval Multiple typographical inaccuracies revised Answers to frequently asked questions added	April '17
06	"	Signal to noise ratio corrected	June '17

12 Disclaimer

All products, product specifications and data are subject to change without notice to improve reliability, function or design or otherwise.

Hypex Electronics BV, its affiliates, agents, and employees, and all persons acting on its or their behalf (collectively, "Hypex Electronics"), disclaim any and all liability for any errors, inaccuracies or incompleteness contained in any datasheet or in any other disclosure relating to any product.

This subassembly is designed for use in music reproduction equipment only. No representations are made as to fitness for other uses. Except where noted otherwise any specifications given pertain to this subassembly only. Responsibility for verifying the performance, safety, reliability and compliance with legal standards of end products using this subassembly falls to the manufacturer of said end product.

LIFE SUPPORT POLICY: Use of Hypex products in life support equipment or equipment whose failure can reasonably be expected to result in injury or death is not permitted except by explicit written consent from Hypex Electronics BV.